



**DOORS  
YOU'LL LOVE**

**COMING  
HOME TO.**

**Stylish. Secure. Solidor®**

[solidor.co.uk](http://solidor.co.uk)









*“What does your front door say about you?”*



**Solidor®**

Leading the way in secure composite doors



# Introduction

The Solidor Collection is an outstanding range of industry leading, solid timber core composite doors. Each Solidor exceeds building regulation requirements and combines traditional and contemporary styling with a full range of Secured by Design locking which provides a stunning, high quality and secure entrance to any home.

With a thickness of 48mm, a Solidor door is nearly 10% thicker than most alternatives. Each unique solid timber core is completely encapsulated within a highly durable plastic edge banding and two thermo plastic door skins. This means that your customer will never have to worry about painting or varnishing their Solidor.

These doors are exclusively available in the widest range of styles and frame colour options, (24 colours available, please see page 8) with the option of a mobility threshold, making it the perfect solution for easy wheel or push chair access. We offer a comprehensive range of matching coloured frames, that are available with either glass, composite side panel or quarter panel to complement the look of any property.

Solidor composite doors are manufactured to the highest standards. We hold BSI Kite mark accreditation BSI ISO 9001 for quality management, BSI EN1279 for insulating glass units.

We are also PAS24:2016 certified, hold CE Marking and Secured by design licences, and are members of the prestigious GGF and Association of Composite Door Manufacturers.

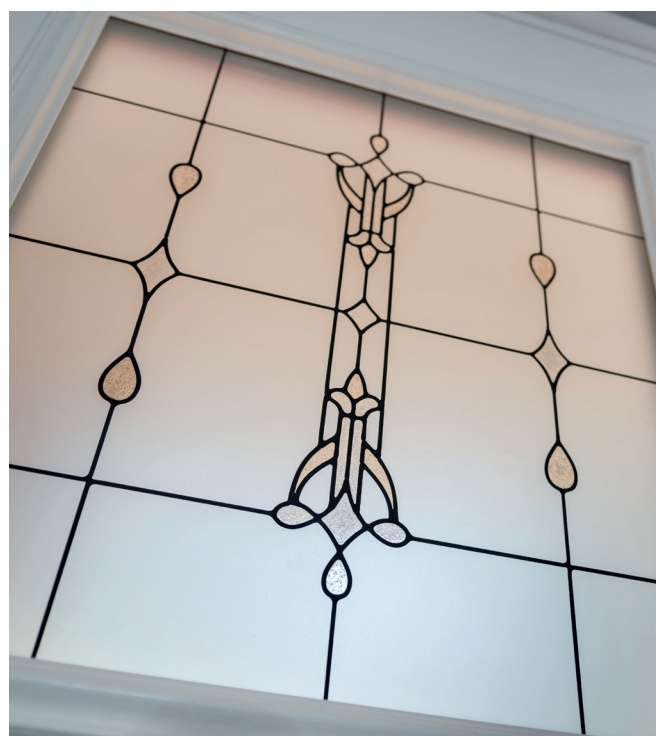

## Contents

- 05. Choosing Solidor
- 06. Security
- 08. Colour Options
- 10. The Italia Collection
- 20. The Traditional Collection
- 30. Solidor French Doors
- 32. Solidor Stable Doors
- 34. Side Panels
- 36. Furniture & Accessories
- 41. Glazing Options
- 42. Jo Downs Range
- 44. Art Deco Range
- 46. Decorative Glass

PLEASE NOTE THE IMAGES SHOWN WITHIN THIS BROCHURE ARE FOR ILLUSTRATION PURPOSES ONLY. PLEASE USE THIS BROCHURE AS A REFERENCE, SLIGHT CHANGES CAN OCCUR DUE TO CONTINUOUS IMPROVEMENT.



# Choosing Solidor®

**We understand that knowing your home and family are protected is a major factor when choosing a new door.**

You can rest assured that with our door construction, coupled with our unique, reinforced door frame and Secured by Design locking systems, your home will be as safe as can be when you choose Solidor.

## A typical foam filled door construction

**40mm Foam Filled Centre** performs thermally, but because this is a foam fill it is neither solid, nor secure.

**Visible Edge Banding** as a result you will often see a different coloured line running the length of the door.

**Gel Coated GRP Outer Skin** may offer protection but can be easily cut through. Also, because every door is a white blank that is surface painted they show scratches very easily.

**3 Chamber Profile** which use valuable steel or aluminium reinforcements. Also, you should check if they are lead free.

## Solidor's unique solid timber construction

**44mm Solid Timber Core (48mm including skin)** that is thermally efficient and extremely secure.

**Hidden Edge Banding** so the front of your door remains a solid, glorious slab of colour.

**'Through' Colour ABS Skins** made from the same durable plastic as Lego®. Also, because the entire skin is made of a solid colour, any scratches are practically hidden.

**Lead Free, 5 Chamber Profile** which uses 100% recycled reinforcing. Generally, the more chambers that a profile uses, the stronger and more thermally efficient they are.

**Wood Grain Effect Skin** that gives all of the aesthetics of timber, but without the time consuming maintenance.

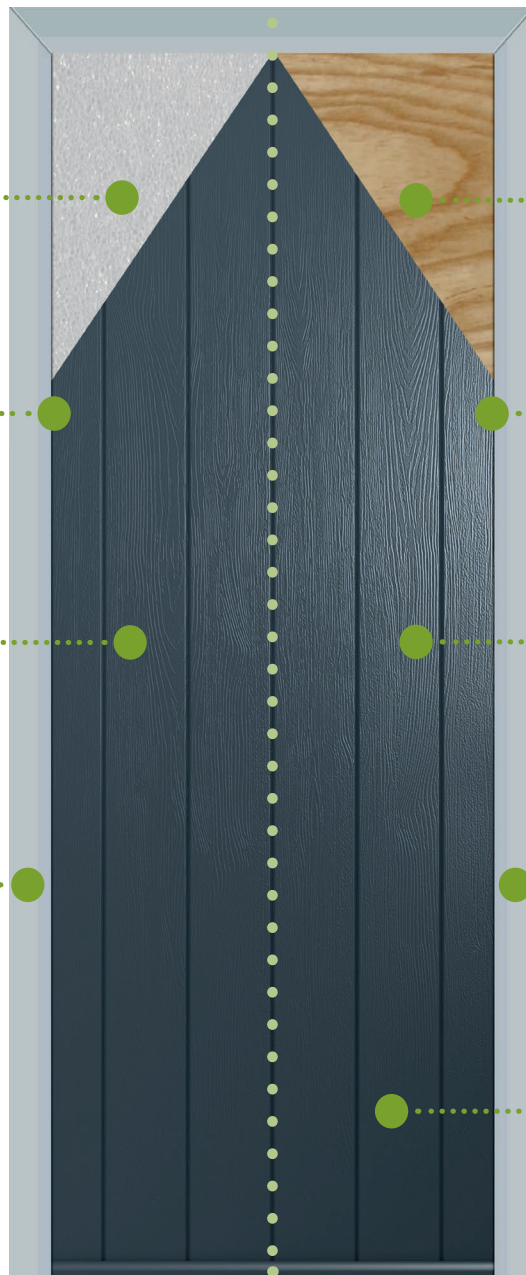

To see our security test video visit [www.solidor.co.uk/tv](http://www.solidor.co.uk/tv)





# Reasons to feel Safe & Secure



You can rest assured that with our door construction, coupled with our unique, reinforced door frame and Secured by Design locking systems, your property will be as safe as can be when you choose Solidor.

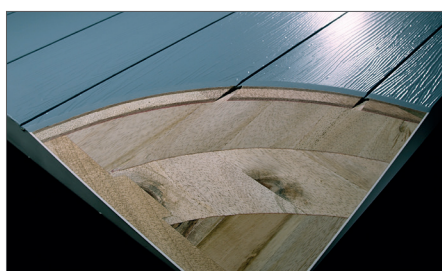

## 48mm Solid Timber Core

At Solidor, security and safety are amongst our highest priorities. Sadly a property is burgled in the UK every minute, but our 48mm\* thick solid timber core gives you the strongest and most secure option available in a residential door.

\*44mm Solid Timber Core  
(48mm including skin)

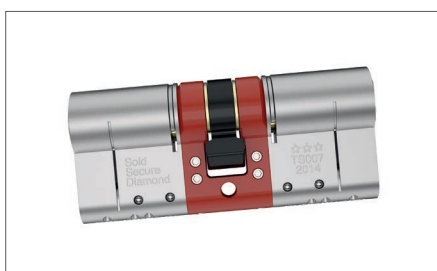

## The highest Standard of Cylinder

You will be glad to know that as standard, our high security cylinder, features anti-pick, anti-drill, anti-bump and anti-snap technology. Protecting you and your home.



## Avantis Multi-point Locking

As standard we fit our exclusive Avantis Secured by design locking systems. With larger hooks for added strength.

*Different locking systems we offer :*

- Avantis multi-point lock
- Standard slam shut auto lock
- Heritage slam shut lock
- Key operated multi
- AV3 mech lock



## Lock Options



### The Largest Deadbolt in the UK!

On lever handle doors we fit our Avantis Secured by Design lock. This has the industry's largest 25.4mm deadbolt for added security.

It also has built in compression and dampeners to give the smoothest operation on the market.



### Automatic AV2 Mech Lock

The automatic AV2 mechanical lock operates as a slam secure lock as soon as the door is closed.

AV2-B allows home owners to unlock the door from a distance using a remote control device. (Only available with a lever/lever handle)

AV2-E is our electronic locking system which incorporates a 12v electric motor, causing the mechanism to withdraw the hooks and latch. The motor can be powered by a door entry system of the homeowners choice (door entry system to be sourced separately).



### Automatic AV3 Mech Lock

The new autoLock AV3 automatic multi-point locking system has a magnetic trigger in the frame. Two self-locking sturdy hooks provide security and two sealing elements ensure correct closure.

A daytime release function is integrated as standard with easy one-handed operation or motorised release.

## Ultion £2000 Guarantee

Every Solidor is fitted with Ultion as standard that means if an intruder breaks into your home as a result of snapping your Ultion cylinder lock, Ultion will pay £2000.



£2000  
GUARANTEE

## Lock Positioning



### Standard Slam Shut Auto lock

The Slam Shut lock is an automatic multi-point locking system. It features two self-locking hooks to provide additional security and two sealing elements ensure correct closure.



### Heritage Slam Shut Lock

The aesthetics of a traditional rim latch, but incorporates the latest high security slam shut technology. The lock automatically engages as the door closes.



### Key Operated Multi-Point Lock

Customers who do not want handles can upgrade to our key operated multi-point lock.

## Supreme Security Accreditations





# A Colourful Entrance

## Luxury Range

We offer the **largest** range of colours from stock in the UK.

Choose from **24 colours** for the inside and / or the outside of your door. You also have 9 frame colour options to choose from. When selecting your colour from this guide please be aware we advise you to ask for a colour swatch to check both colour and grain structure.

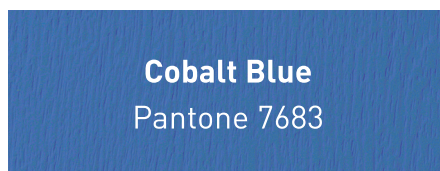
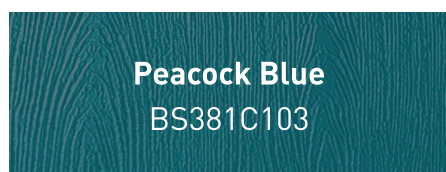
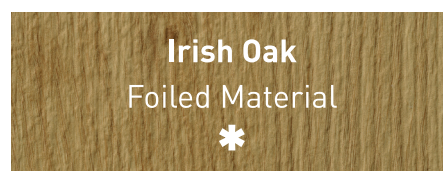

\* Available as a matching frame option

▲ Frame option for Painswick, white internal only



## Premium Range

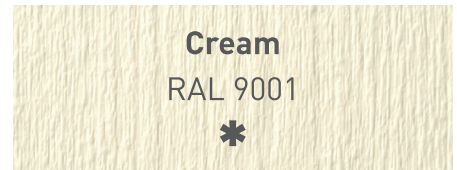
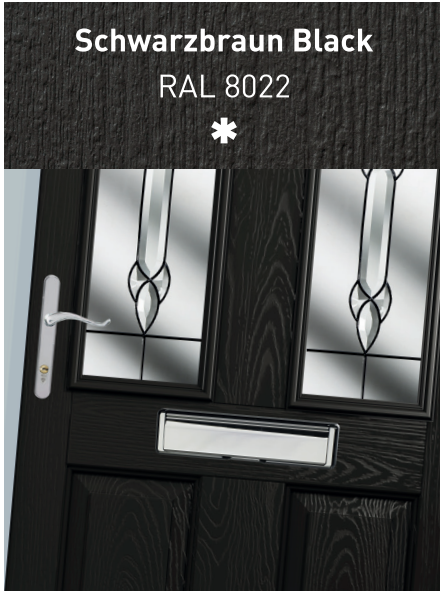

## Standard Range

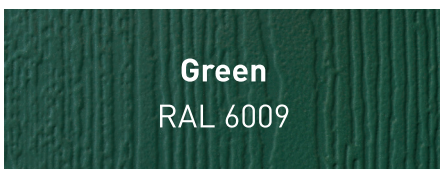
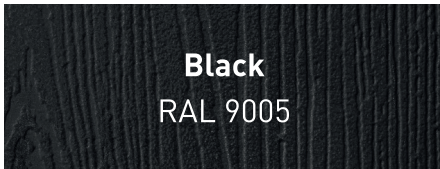

Please note that all RAL colours are LAB matched and a slight difference in colour can occur. If you are matching paint to one of our doors it is advised that you ask for a colour swatch.

\*Due to the limitations of the lithographic printing process, colour samples may not be an exact match to actual doors.









# THE Italia Collection

The Italia collection from Solidor is a new generation of truly contemporary designs which will add a touch of style to your home. Carefully designed and crafted from the finest materials, every door in the Italia collection has a definite style inspired by the Italian passion for design.

Each door is handmade in Staffordshire, ensuring the finished product is of an outstanding quality and made as individual as can be. Choose from a range of glass styles and door furniture which have been carefully chosen with the latest fashion and designs in mind. All of the doors in the Italia Collection are also available with Warwick Glass - hand made so no two pieces are ever the same.



# Milano



*Inspired by the greats of Italian design. The Milano is a luxurious addition to the Italia collection, offering a sophisticated, contemporary feel to any property.*

The textured grain, linear design and off-set modernist glazing style, paired with contemporary accessories elevates the Milano as a door style which encompasses quality and aesthetic appeal.



Stippolyte



London Etch Border



Bullseye



Potomac

Colour - Anthracite Grey  
ES3 1800 door handle and key  
only security locking option





# Palermo



*Putting the Solid in this Solidor, choosing our Palermo design means opting for elite simplicity.*

The Palermo's aesthetic is a stand out design for any home. We love our Palermo in a muted tone or traditional wood look, enhanced with one of our bar handles to achieve effortless sophistication that is bound to make any neighbour Solidor green with envy.



Colour - Luxury Walnut  
ES3 1800 door handle

See the full range of glass options in our dedicated glass brochure at [www.solidor.co.uk](http://www.solidor.co.uk)



## Trieste

All Italia doors are available with or without grooves



Colour - Green  
Glass - Dorchester

## Rimini



Colour - Irish Oak  
Handle- ES3 1800mm

## Messina



Colour - Rosewood  
Handle - ES3 800mm

## Brescia



Colour - French Grey  
Handle - ES3 1800mm

## Ancona



Colour - Cream  
Handle - EK53

## Ancona Solid



Colour - Golden Oak  
Handle - ES3 1800mm

Midnight Grey	Rich Aubergine	Irish Oak	Peacock Blue	French Grey	Chartwell Green	Lavender	Cobalt Blue	Walnut	Duck Egg Blue	Twilight Grey	Painswick
Tangerine	Schwarzbraun	Anthracite Grey	Golden Oak	Black	Ruby Red	White	Cream	Rosewood	Foiled White	Green	Blue



## Parma



Colour - Schwarzbraun  
Handle - ES3 1800mm

## Sorrento



Colour - Cream  
Handle - ES3 400mm

## Biella



Colour - Foiled White  
Handle - Lever/Lever

## Venice

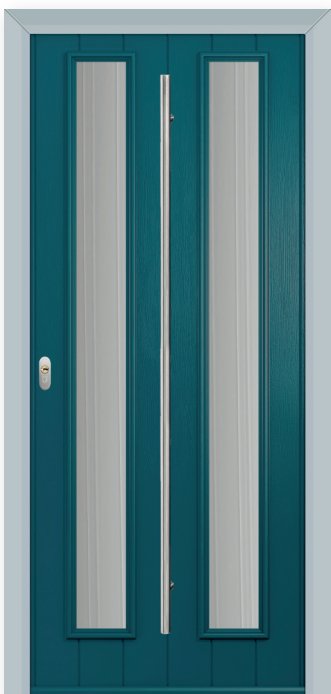

Colour - Peacock Blue  
Handle - ES3 1800mm

## Garda



Colour - Painswick  
Handle - ES24

## Amalfi



Colour - Anthracite  
Handle - ES21

See the full range of glass options in our dedicated glass brochure at [www.solidor.co.uk](http://www.solidor.co.uk)



## Modena



Colour - Anthracite Grey  
Handle - ES24

## Genoa



Colour - Golden Oak  
Handle - ES3 800mm

## Siena



Colour - Walnut  
Handle - ES23

## Pisa



Colour - Ruby Red  
Handle - ES23

## Bologna



Colour - Painswick  
Handle - ES24

## Roma



Colour - Tangerine  
Handle - ES21





## Monza



Colour - Painswick  
Handle - ES21

## Verona



Colour - Duck Egg Blue  
Handle - ES3 1800mm

## Naples



Colour - Schwarzbraun  
Handle - Lever/Lever

## Turin



Colour - Chartwell Green  
Handle - ES21



See the full range of glass options in our dedicated glass brochure at [www.solidor.co.uk](http://www.solidor.co.uk)



## Italia Accessories

Designer handle range for our key only operated and slam shut auto locks



ES3 800mm



ES24



ES23



ES3 1800mm



ES3 800mm



ES3 400mm

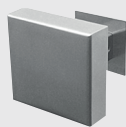

EK570



ES21



ES24



EK53



ES23

Bar handles will be at least 110mm from the edge of the door slab.

## Pilkington Texture Glass Warwick™

This design is unique amongst our patterns because it is produced using a different manufacturing method. Pilkington Texture Glass Warwick™ is a random pattern that is added along the central portion of the pane and this has implications when cutting the glass down into finished sizes. It is possible, if a pane is small enough, it could be cut with no evidence of the pattern at all.

None of the Pilkington patterns are designed to have an orientation (an up side) but care needs to be taken with adjacent panes that the pattern direction is maintained. There is a linear nature to Pilkington Texture Glass Warwick™ and so householders should be aware that there could be aesthetic implications when choosing this design. Also, for the glass supplier the result may be that this pattern is less accommodating when cutting and may result in a greater proportion of seldge from the original glass plate.



Warwick Glass available in all of our Italia doors

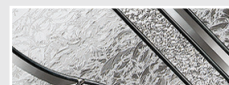

Abstract Glass available in the Pisa, Turin and Siena

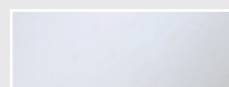

Satin Glass available in all of our doors









# THE Traditional Collection

The Traditional collection from Solidor, brings classic designs into the modern era. Each door design is suited to both traditional and modern properties alike, and will add a touch of elegance to every home.



# Ludlow



Colour - Painswick  
Glass - London Etch

*The Ludlow is Solidor's most popular style of composite door.*

It's perfectly suited to both rich colours such as red and traditional woodgrain effects such as rosewood. The two glazed panels can help shape the visual appearance of the overall door with options ranging from the traditional diamond to the more contemporary abstract. There's also the option of a solid door, which looks great in Irish Oak.



The Victorian



Caledonian Rose



Dorchester



Abstract



Simplicity



Park Lane  
Bespoke



Elegance



Brilliante





# Conway



Colour - Foiled White  
Glass - Caladonian Rose

*The Conway is a highly versatile composite door solution.*

This door can be designed as a completely solid door, or with just the top fanlight glazed or even with a fully glazed design to take account of the vast array of glass options. The square or quad glass options can be manufactured in grey, black and red colours for added elegance. Our advice is to also choose a bold door knocker for this design!



Trio Square (Red)



Elegance



Zinc Art Star



Reflections



Quad (Blue)



Simplicity



CTL 6.1



Dorchester





# Beeston



*The Beeston makes for a fantastic composite stable door.*

Given the size of the glazed area, it's possible to create something particularly individual when combined with one of the major colours, or you can even specify an integral blind. Like all the doors in the Solidor range, there's the option of chrome, brushed, gold, black chrome, black and white door furniture. So go on, be bold in your design!



Abstract



Park Lane



Simplicity



Reflections



Modena



Blind available in white only

Integrated Blind



Brilliante



Linear



Colour - Black  
Glass - Elegance

See the full range of glass options in our dedicated glass brochure at [www.solidor.co.uk](http://www.solidor.co.uk)



## Stirling



Colour - Blue  
Glass - Oceanic  
Handle - Lever/Lever

## London



Colour - Golden Oak  
Glass - Dorchester

## Berkeley



Colour - Duck Egg Blue  
Glass - Dorchester

## Edinburgh

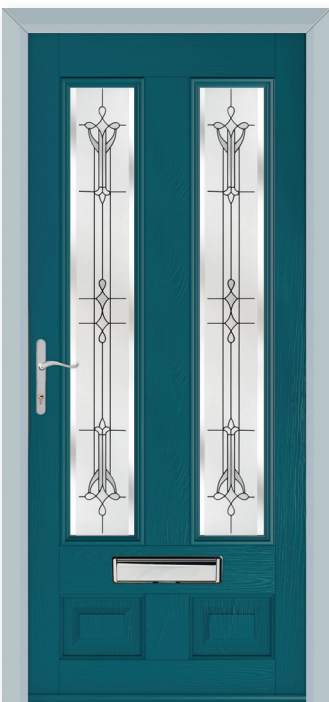

Colour - Peacock Blue  
Glass - Park Lane

## Alnwick



Colour - Chartwell Green  
Glass - Modena

## Nottingham



Colour - Schwarzbraun  
Glass - CTB19.2





## Harlech



Colour - Walnut  
Glass - CTB 17.2

## Stafford



Colour - French Grey  
Glass - Royale

## Thornbury

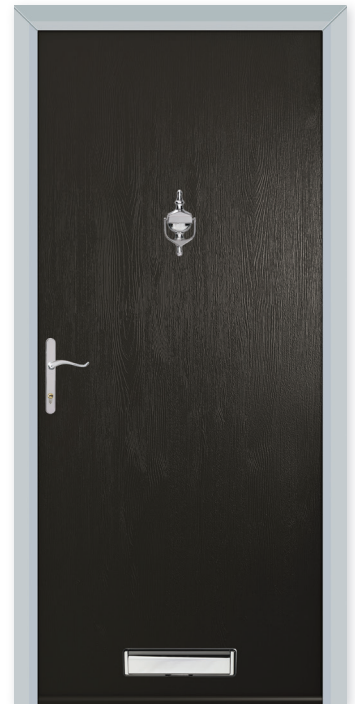

Colour -Schwarzbraun

## Tenby 2



Colour - Rich Aubergine  
Glass - Reflections

## Tenby 4



Colour - Painswick  
Glass - Quad (Grey)

## Windsor



Colour - Anthracite Grey

## Windsor Solid



Colour - Irish Oak

See the full range of glass options in our dedicated glass brochure at [www.solidor.co.uk](http://www.solidor.co.uk)



# The Flint Collection



Flint 1  
Colour - Blue  
Glass - Trio Square (Green)

*Doors from the Flint Cottage Range are the perfect fit for British cottages.*

It's fast becoming the number one choice for homeowners with cottages, farmhouses or for those looking for a side door option, thanks to its vertical panelled appearance. We have also added a contemporary twist to the design with the introduction of single or triple diamond shaped glass features to broaden its appearance. It's also proving a great option as a stable door.



Trio Square  
(Butterscotch)



Trio Square  
(Sea Green)



Satin



Stippolyte



Star Clear



Star Black



London Etch



Bullseye







Flint Solid  
Colour - Duck Egg Blue



Flint Square  
Colour - Ruby Red  
Glass - Bullseye



Flint Beeston  
Colour - Midnight Grey  
Glass - Square Lead



Flint 2  
Colour - Cream  
Glass - CTB 18.1



Flint 3  
Colour - Chartwell Green  
Glass - Trio Square Green



Flint 4  
Colour - Golden Oak  
Glass - Diamond Lead



Flint 5  
Colour - Painswick  
Glass - Modena

See the full range of glass options in our dedicated glass brochure at [www.solidor.co.uk](http://www.solidor.co.uk)





## IDEA

Use wall spaces to display an alternative classic letterbox, in a style to complement your door.

*TIP: Make a statement and frame the doorway with a walled path for a truly grand entrance!*

# Classic

British design



# Ludlow

With a truly natural looking woodgrain effect, our classic British door designs are *timeless*.

## Achieve an authentic Victorian look with the Ludlow, fast becoming **Britain's most popular door.**

With simple clean lines, the Ludlow has the power to create either a modern or a traditional entrance for your home. Available as a solid door for added privacy, or with two glazed panels, the Ludlow combines classic Victorian design with modern materials. Either option will create a polished and sophisticated entry.

### ▼ *Lighten it up*

Open up your front entry with glazed panels on both sides of your door. They will flood your hallway with light, make your entry seem larger, and enhance your home's architectural style.



### ◀ *All in the detail*

Our elegantly shaped handles and accessories in sleek chrome suit this Ludlow perfectly.

Visit [www.solidor.co.uk/accessories](http://www.solidor.co.uk/accessories) to view our range of hardware

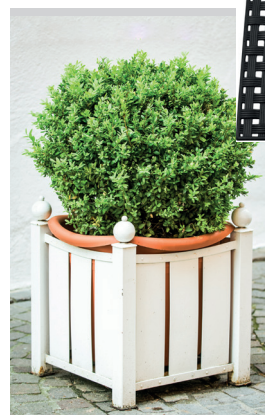

### ▲ *Back to basics*

Keep it simple by adding ornate planters either side of the door or a hard wearing welcome mat - enough to complete the subtle look in smaller spaces.

## Which Colour?

Choose Schwarzbraun with stained glass and traditional door furniture to retain the door's original Victorian charm, or give it a contemporary edge by opting for French Grey with polished chrome accessories.

**Choose your colour from our new and updated range on page 8 →→**

Schwarzbraun

French Grey



# French Doors



All of our designs, in all of our colours are available in a French Door option, with a range of handle options, encompassing a high security, adjustable, multipoint locking system.





Available as inward or outward opening doors. Because our French door range is so vast, please contact us for the minimum and maximum sizes before you order your set.

NOTE: Available with UPVC and aluminium threshold on inward opening sets, and UPVC only on outward opening sets.

Flush, integrated two way lever, which throws the shootbolts and removes the need for a lever handle and cylinder to give the option to use our Italia Collection handles on both leaves, alternatively, go for lever operated!

Standard option is both doors to be lever handle operated.



# Stable Doors

Did you know that the majority of our Traditional Collection and a selection of our Italia Collection door styles can be available as (open in only) stable doors? With the choice of any colour from our range available on any side, contact us for more details today!



All of our stable doors come with a high security, fully adjustable multi-point locking system. They are also keyed alike, benefit from an internal thumb turn cylinder on the top and bottom half and have a latching security bolt as standard.









# Side Panels

**Complement your property with a full range of matching full height and half side panels.**

(contact us for details on the full range of side panels available)





Half Moulded



Half Flat Grain



Quarter Moulded



Milano Side Panel



Milano



Brescia



Thornbury



Ludlow



Harlech



Available in all of our colour options!

Tenby

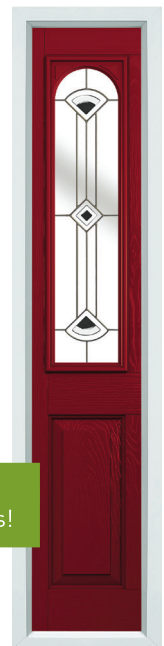

Nottingham



# Furniture & Accessories

A selection of beautiful accessories and high security locks to perfectly complement your choice of door. Whether contemporary or traditional, you will find an accessory to really make your door stand out.

## Door Knockers

### Doctor



- Chrome
- Gold
- Brushed
- Black Chrome
- White
- Black

### Premium 7" Doctor



- Chrome
- Gold

### Urn

Available with or without spyhole



- Chrome
- Gold
- Brushed
- Black Chrome
- White
- Black
- Antique Black

### Pony Tail



- Chrome
- Gold
- Brushed
- Black Chrome
- White
- Black

### Stainless Steel



- Steel

### Lion

Not available on Tenby 4, Conway 3, Ludlow, Edinburgh, Harlech or Nottingham



- Chrome
- Gold
- Black Chrome
- White
- Black
- Brushed Ali

## Viewer



- Chrome
- Gold
- White
- Black

## Letterplates



- Chrome
- Gold
- Brushed
- Black Chrome
- White
- Black
- Antique Black



## The Architectural Range

Knocker

 Brushed



Lever / Lever inline handle

 Brushed



Letterplate (Opens inwards)

 Brushed



## The Classical Range

Bullring Knocker

 Chrome

 Gold

 Antique Black



Lever / Lever inline handle

 Chrome

 Gold

 Antique Black



Pull Knob

 Chrome

 Gold

 Antique Black



Letterplate (opens inwards)

 Chrome

 Gold



 Antique Black





## Butt Hinge









-  Gold
-  White
-  Black

## Hinges

Our new slimline, PAS 24 tested, face fixed flag hinge is sleek and modern. Available for open in doors only.







-  Chrome
-  Gold
-  Brushed
-  Black Chrome
-  White
-  Black

## Handles

A large range of premium quality handles to complement our doors. Available with a choice of a standard lever or one of the three exclusive options across the whole range of finishes.







### Swan Hardex



-  Chrome
-  Gold
-  Brushed
-  Black Chrome
-  Antique Black







### Lever Hardex



-  Chrome
-  Gold
-  Brushed
-  Black Chrome
-  White
-  Black
-  Antique Black



### Lever Pad



-  Chrome
-  Gold
-  Brushed
-  Black Chrome
-  White
-  Black
-  Antique Black



## Door Knob



-  Chrome
-  Brushed

## Trojan Letterplates

Stainless steel specifically for coastal properties

-  Chrome
-  Brushed
-  Gold

Standard



TS008 SBD Only (White internal)



## Trojan Urn

Stainless steel specifically for coastal properties





-  Gold
-  Chrome
-  Brushed



## Trojan Handles

Stainless steel specifically for coastal properties



-  Gold
-  Chrome
-  Brushed









## Extra Security





Security Door Guard



-  Chrome
-  Gold
-  Brushed
-  White
-  Black

Stable Door Latch Suited where possible





-  Chrome
-  Gold
-  Brushed
-  Black

## Ironmongery

We have a range of stunning traditional knockers and handles that add a real touch of class.



Traditional Avon Slimline



-  Black
-  Pewter



Traditional Monkey Tail



-  Black
-  Pewter



Traditional Cottage



-  Black
-  Pewter

Traditional Pull Knob





-  Pewter
-  Black

Teardrop Knocker

Not available on Tenby 4, Conway 3, Ludlow, Edinburgh, Harlech or Nottingham





-  Pewter
-  Black

Handmade Ring

Not available on Tenby 4, Conway 3, Ludlow, Edinburgh, Harlech or Nottingham





-  Pewter
-  Black

Traditional Letterplate

Letterplate for illustrative purposes only  
Opens inwards









-  Pewter
-  Black

## Finger pulls

Available with the heritage lock



-  Chrome
-  Gold
-  Satin
-  Antique Black
-  Black Chrome
-  White
-  Black



# Finishing Options

## OUTER FRAME OPTIONS

Which frame would you like? Choose from Kömmerling Chamfered C70 or Sculptured O70 outer frame.



## EDGE BANDING COLOURS

White as standard, brown on Rosewood / Walnut, Anthracite Grey on Schwarzbraun, Black, and Anthracite Grey when coloured both sides, caramel on Golden Oak and Irish Oak when coloured both sides. For all other dual colour combination white edge band is use.



## Thresholds

To allow for every circumstance we offer the largest range of door thresholds. The AM3 and AM5EX aluminium threshold are both Part 'M' compliant within the latest Building Regulations for easy access.

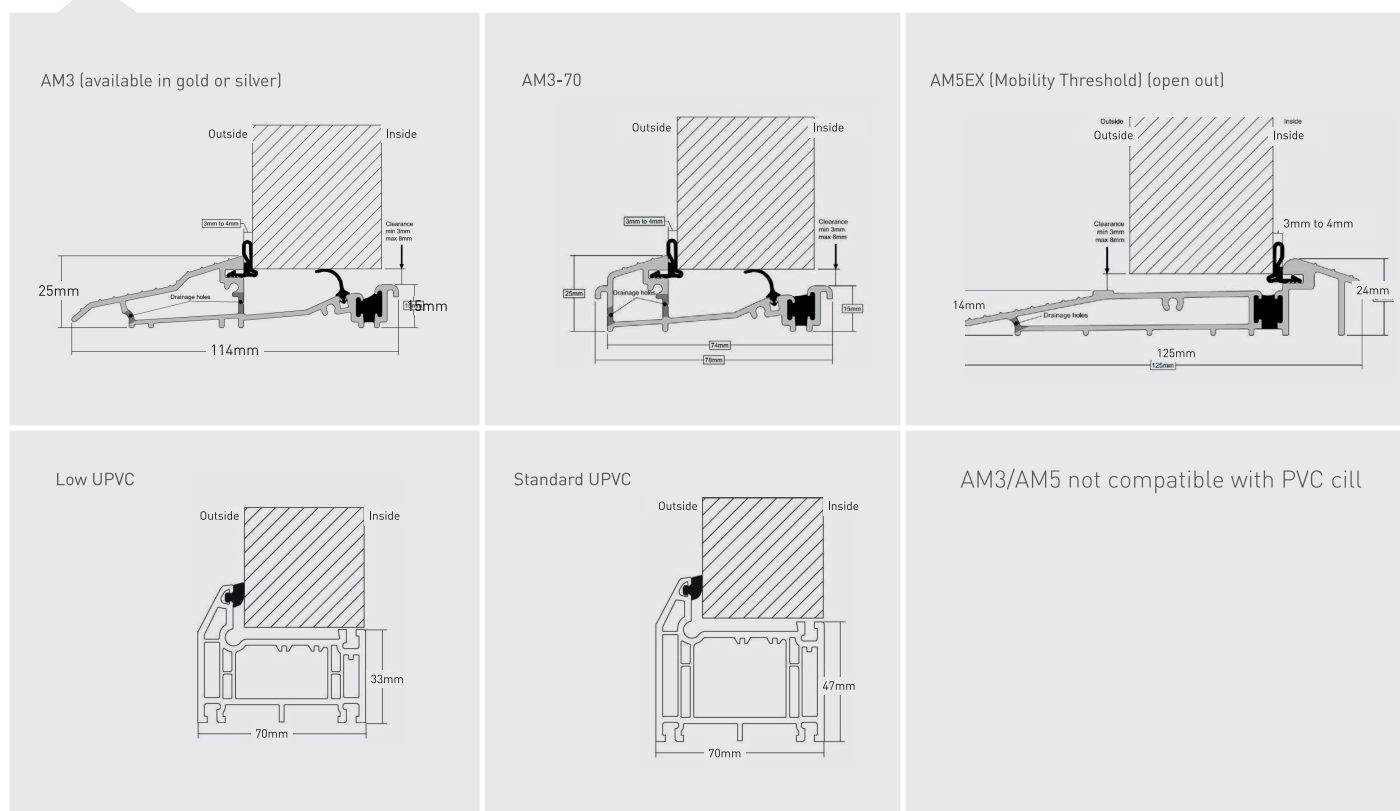





# Amazing Glazing

A fine selection of beautiful glass to perfectly complement your choice of door. Whether modern or traditional you will find a glass style to really make your door stand out.



# Jo Downs

HANDMADE GLASS

**Solidor**<sup>®</sup>  
EXCLUSIVE

Jo Downs is one of the world's most respected fused glass designers. Working from her Cornwall studio, Jo's work draws inspiration from the beautiful coastal landscape while her advanced fusion techniques allow for the creation of abstract designs of great individuality and depth.

\*Please be aware that each piece is individually hand crafted and therefore no two pieces are the same.



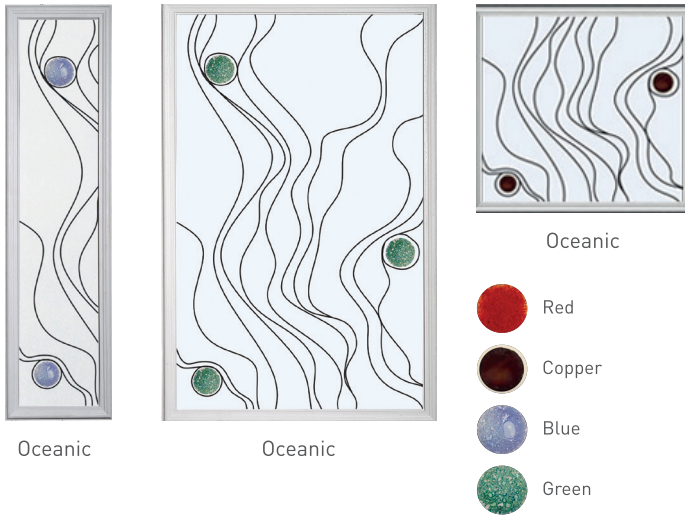

The stunning Cornish landscape that inspires Jo's work

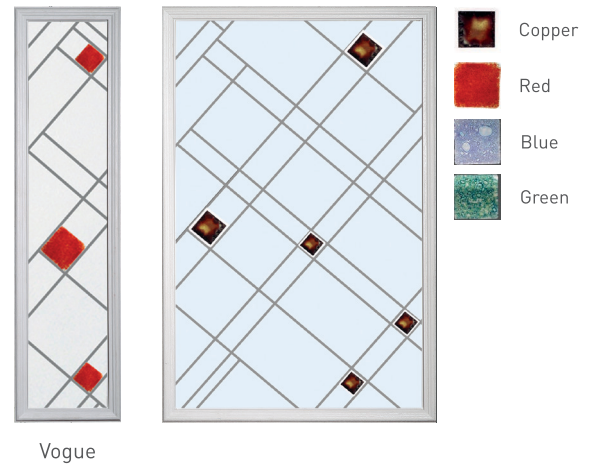

Using carefully selected materials, the glass tiles are laid out and then baked in a kiln, producing really eye catching results.

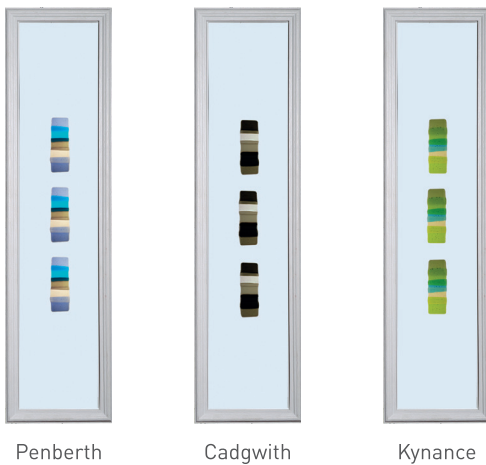

Hand crafted, each piece of glass is unique, turning the door to your home into a stunning work of art.



**Solidor**<sup>®</sup>  
EXCLUSIVE

# Artistic Glass

Inspired by classical artistic styles, such as art deco, minimalism, and the impressionist movement, The Modernist Range of glass is unique to Solidor.





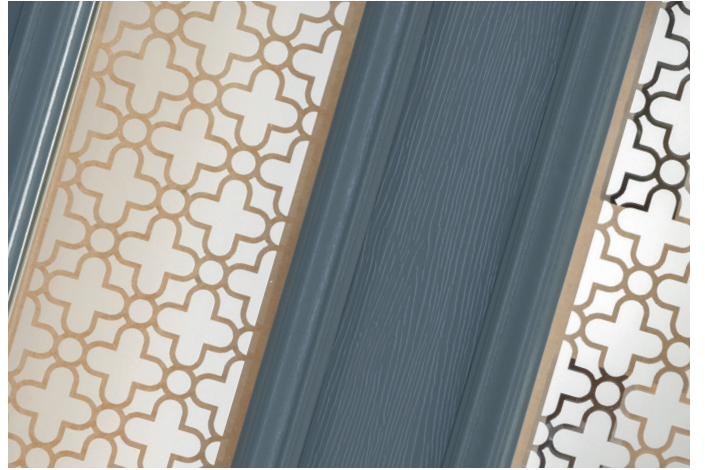

Fairmont



Paramount

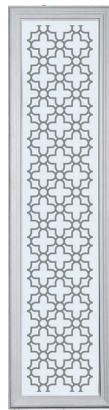

Wiltern



Gaumont



Tate



Fairmont

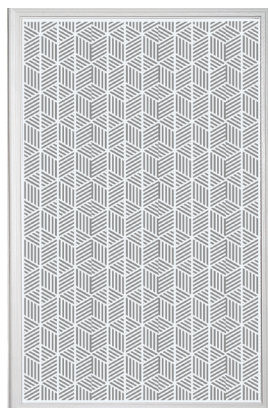

Paramount

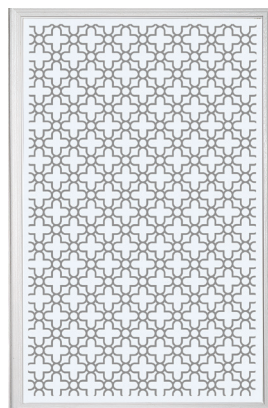

Wiltern

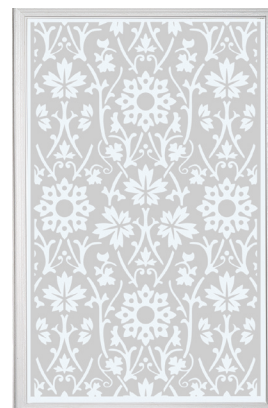

Tate



# Traditional Range Backing glass required



**Trio Square**  
Black



**Trio Square**  
Blue



**Trio Square**  
Butterscotch



**Trio Square**  
Green



**Trio Square**  
Grey



**Trio Square**  
Red



**Trio Square**  
Sea Green



**Diamond**  
Black



**Diamond**  
Black & White



**Diamond**  
Butterscotch



**Diamond**  
Red



**Quad**  
Black



**Quad**  
Blue



**Quad**  
Grey



**Quad**  
Red



**CSB 5.1FT**



**CGB-F**  
Cassette only not internal glass



**CTL 6.1**

Available in white only



**Open Blind**  
Clear glass only



**Closed Blind**



**CTB 12.3**  
Clear bevels available



**CTB 18.1**



**Star Clear**



**Star Black**



**Bullseye**



# Decorative Glass

Backing glass not optional.



Matrix



Modena  
End result dependent  
on door style

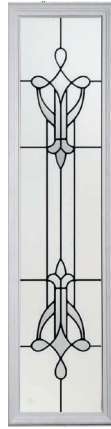

Park Lane  
Bespoke



Victorian



Zinc Art Star



Caledonian  
Rose Handed



Dorchester



Etched Squares



Linear



London Etch  
Border



Abstract



Brilliante



Clarity - GOLD



Elegance



Simplicity



Potomac

Backing glass required



Prairie



Reflections



Royale



CFT 2.1



CTB 17.2



CTB 19.2



CTL 31.2B



Jewel





To create your perfect Solidor go online

[www.doordesigner.solidor.co.uk](http://www.doordesigner.solidor.co.uk)



**MASONITE®**





